

**HYMO**

# MAXIMA

– for heavyweight tasks



tel +46 11 368700 • [www.hymo.com](http://www.hymo.com)

# Hymo Maxima - a lift table line-up combining high capacity and precision.

Hymo Maxima range of lift tables are designed for truly heavy weight, high performance applications.

Hymo Maxima lift tables are used for levelling fixed and moving differences in the flow of goods, within all types of industry in production, storage and distribution.

Hymo Maxima is often an essential part in building up ergonomic working environments. Where large, high

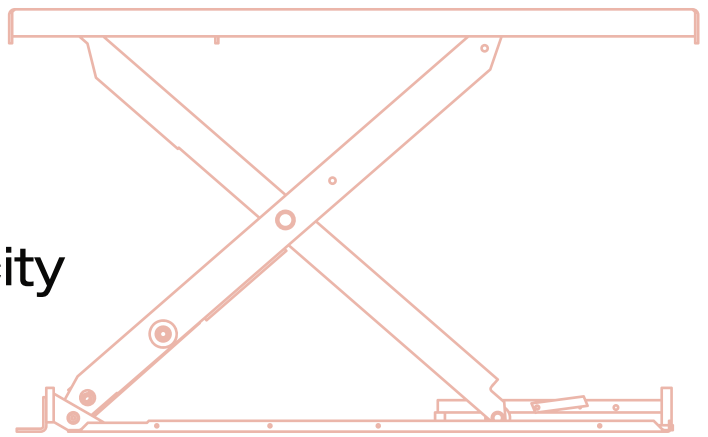

The function and the precision of the products are being utilised on assembly lines and in automated production processes in all types on industry.

To meet the customers' demand of high quality and safety, all lift tables are tested before delivery. When the Hymo product has customised equipment, it is also tested in the right environment.



BX  
BXX  
BXXX  
BXT  
DX  
DXT  
LX



capacity lifting in tough operating and environmental conditions are required the Hymo Maxima plays an important role.

Hymo Maxima products bear the CE mark and meet lift table standards in accordance with EN 1570. The hydraulic power unit complies with EN 982 and electrical system EN 60204. The motor has protection class IP55, control system and other electrical components IP 65.

## Hymo AB

Hymo has developed and manufactured lift tables for more than 50 years. Hymo scissor lift tables are based on long experience and an in-depth track record in this market.

Hymo AB is one of the leading distributors of lift tables in Europe with head office and production in Åby Sweden and subsidiaries in England, France, Germany and Holland. Distributors in Europe, Russia, Australia, Hongkong and Singapore.

*In the technical description the basic standard is given. Customised equipment is possible to a great extend.*

*We reserve the right to alter specifications without prior notice.*

### The Hymo Maxima program consists of:

- Type BX, BXX, BXXX and BXT page 3
- Type DX, DXT page 6
- Type LX page 6
- Accessories page 9

## Hymo Lift table BX SINGLE-SCISSORS

Hymo BX has a lifting capacity up to 3000 kg and is available in a great amount of standard sizes. The BX is also available in special sizes on demand. A built-in power unit is standard.



## Hymo Lift table BXX VERTICAL DOUBLE-SCISSORS

Hymo BXX is available in standard sizes and in special sizes on demand. A separate power unit is standard but the BXX10-15/8 and BXX15-15/8 has a built-in power unit as standard.



## Hymo Lift table BXXX VERTICAL TRIPPLE-SCISSORS

Hymo BXXX is an alternative for high lifting heights with the advantage of rather small platform length. A separate power unit is standard.



## BX, BXX, BXXX AND BXT

Hymo BX, BXX, BXXX and BXT are designed for tough operating and environmental conditions and high performance applications. The high operational reliability and long service life of BX-tables has been demonstrated in all types of industry, on vehicle production lines and other production-related conveyor systems.

Hymo also has the ability to manufacture special units outside of the ranges specified in this brochure.

An extensive accessory range makes it possible to optimally adapt every table to its intended application.



## Hymo Lift table BXT HORIZONTAL DOUBLE-SCISSORS

Hymo BXT is available in standard sizes and in special sizes on demand. A separate power unit is standard.



## Hymo Lift table BX



Single-scissors

TYPE	BX10-8/6	BX10-11/6	BX10-16/8	BX10-16/12	BX10-16/18	BX22-8/8	BX22-8/12	BX22-8/18	BX20-11/8	BX20-11/12	BX20-11/18	BX20-13/8	BX20-13/12	BX20-13/18	BX20-16/8
LIFTING CAPACITY, Kg	1000	1000	1000	1000	1000	2000	2000	2000	2000	2000	2000	2000	2000	2000	2000
LIFT TRAVEL, mm	800	1100	1650	1650	1650	800	800	800	1100	1100	1100	1300	1300	1300	1650
CLOSED HEIGHT, mm	205	240	260	260	260	205	205	205	250	250	250	260	260	260	300
PLATFORM LENGTH, mm	1350	1700	2500	2500	2500	1350	1350	1350	1700	1700	1700	2000	2000	2000	2500
PLATFORM WIDTH, mm	600	600	800	1200	1800	800	1200	1800	800	1200	1800	800	1200	1800	800
LIFTING TIME, s	17	19	38	38	38	34	34	34	38	38	38	38	38	38	47
MOTOR POWER, kW	1.4	1.4	1.4	1.4	1.4	1.4	1.4	1.4	1.4	1.4	1.4	1.4	1.4	1.4	1.4
WEIGHT, kg	258	400	550	670	720	303	350	400	455	530	580	500	600	650	580

## Hymo Lift table BXX



Vertical double-scissors

TYPE	BXX10-15/8	BXX15-15/8	BXX15-15/12	BXX20-20/10	BXX20-20/18	BXX20-38/12	BXX20-38/18	BXX20-43/12	BXX30-30/13	BXX40-30/15
LIFTING CAPACITY, Kg	1000	1500	1500	2000	2000	2000	2000	2000	3000	4000
LIFT TRAVEL, mm	1500	1500	1500	2000	2000	3800	3800	4300	3000	3000
CLOSED HEIGHT, mm	315	315	315	500	500	800	800	650	700	700
PLATFORM LENGTH, mm	1350	1350	1350	1500	1500	2250	2250	3000	2500	2500
PLATFORM WIDTH, mm	800	800	1200	1000	1800	1200	1800	1200	1300	1500
LIFTING TIME, s	19	38	38	25	25	41	41	43	33	46
MOTOR POWER, kW	1.4	1.4	1.4	2.2	2.2	4.6	4.6	4.6	4.6	4.6
WEIGHT, kg	390	410	520	645	900	1150	1350	1140	1580	1650

## Hymo Lift table BXT



Horizontal double-scissors

TYPE	BXT20-11/6	BXT20-16/8	BXT20-16/12	BXT20-16/18	BXT40-8/8	BXT40-8/12	BXT40-8/18	BXT40-11/8	BXT40-11/12	BXT40-11/18	BXT40-13/8	BXT40-13/12	BXT40-13/18	BXT40-16/8
LIFTING CAPACITY, Kg	2000	2000	2000	2000	4000	4000	4000	4000	4000	4000	4000	4000	4000	4000
LIFT TRAVEL, mm	1100	1650	1650	1650	800	800	800	1100	1100	1100	1300	1300	1300	1650
CLOSED HEIGHT, mm	300	320	320	320	290	290	290	320	320	320	320	320	320	360
PLATFORM LENGTH, mm	3400	5000	5000	5000	2700	2700	2700	3400	3400	3400	4000	4000	4000	5000
PLATFORM WIDTH, mm	600	800	1200	1800	800	1200	1800	800	1200	1800	800	1200	1800	800
LIFTING TIME, s	19	31	31	31	19	19	19	31	31	31	31	31	31	38
MOTOR POWER, kW	3.9	3.9	3.9	3.9	3.9	3.9	3.9	3.9	3.9	3.9	3.9	3.9	3.9	3.9
WEIGHT, kg	950	1350	1570	1620	860	1020	1070	1060	1250	1300	1210	1410	1460	1380

Hymo BX with technical description for some standard sizes.  
Further customisation of the lift tables is possible due to an extensive range of options.

TYPE	BX20-16/12	BX20-16/18	BX30-8/8	BX30-8/12	BX30-8/18	BX30-11/8	BX30-11/12	BX30-11/18	BX30-13/8	BX30-13/12	BX30-13/18	BX30-16/8	BX30-16/12	BX30-16/18
LIFTING CAPACITY, Kg	2000	2000	3000	3000	3000	3000	2900	2900	3000	3000	3000	3000	2600	2600
LIFT TRAVEL, mm	1650	1650	800	800	800	1100	1100	1100	1300	1300	1300	1650	1650	1650
CLOSED HEIGHT, mm	300	300	230	230	230	260	260	260	280	280	280	325	325	325
PLATFORM LENGTH, mm	2500	2500	1350	1350	1350	1700	1700	1700	2000	2000	2000	2500	2500	2500
PLATFORM WIDTH, mm	1200	1800	800	1200	1800	800	1200	1800	800	1200	1800	800	1200	1800
LIFTING TIME, s	47	47	27	27	27	38	38	38	47	47	47	59	59	59
MOTOR POWER kW	1.4	1.4	1.4	1.4	1.4	1.4	1.4	1.4	1.4	1.4	1.4	1.4	1.4	1.4
WEIGHT, kg	680	730	365	425	475	460	540	590	520	610	660	660	760	810

Hymo BXX10-15/8 and BXX15-15/8 have built-in power unit while the other double and tripple scissors tables have separate power unit. In the technical description the basic standard is given. Further customisation of the lift tables is possible due to an extensive range of options.



Hymo BXT has separate power unit. In the technical description the basic standard is given. Further customisation of the lift tables is possible due to an extensive range of options.

TYPE	BXT40-16/12	BXT40-16/18	BXT60-8/8	BXT60-8/12	BXT60-8/18	BXT60-11/8	BXT60-11/12	BXT60-11/18	BXT60-13/8	BXT60-13/12	BXT40-13/8	BXT60-16/8	BXT60-16/12	BXT60-16/18
LIFTING CAPACITY, Kg	3600	3600	5500	5500	5500	6000	5500	5500	5500	5500	5500	5500	5500	5500
LIFT TRAVELE, mm	1650	1650	800	800	800	1100	1100	1100	1300	1300	1300	1650	1650	1650
CLOSED HEIGHT, mm	360	360	290	290	290	320	320	320	340	340	340	390	390	390
PLATFORM LENGTH, mm	5000	5000	2700	2700	2700	3400	3400	3400	4000	4000	4000	5000	5000	5000
PLATFORM WIDTH, mm	1200	1800	800	1200	1800	800	1200	1800	800	1200	1800	800	1200	1800
LIFTING TIME, s	38	38	22	22	22	31	31	31	38	38	38	48	48	48
MOTOR POWER, kW	3.9	3.9	3.9	3.9	3.9	3.9	3.9	3.9	3.9	3.9	3.9	3.9	3.9	3.9
WEIGHT, kg	1600	1650	860	1020	1070	1070	1260	1310	1225	1425	1475	1540	1760	1810

## Hymo Lift table DX



Single-scissors

TYPE	DX30-20/12	DX30-20/15	DX40-16/12	DX40-16/15	DX40-20/12	DX40-20/15	DX60-13/12	DX60-16/12	DX100-15/20
LIFTING CAPACITY, Kg	3000	3000	4000	4000	4000	4000	6000	6000	10000
LIFT TRAVEL, mm	2000	2000	1600	1600	2000	2000	1300	1600	1500
CLOSED HEIGHT, mm	300	300	400	400	400	400	400	400	600
PLATFORM LENGTH, mm	3000	3000	2500	2500	3000	3000	2250	2500	3000
PLATFORM WIDTH, mm	1200	1500	1200	1500	1200	1500	1200	1200	2000
LIFTING TIME, s	41	41	33	33	32	32	38	47	45
MOTOR POWER, kW	2.2	2.2	2.2	2.2	4.6	4.6	2.2	2.2	4.6
WEIGHT, kg	780	860	1100	1210	1260	1380	1020	1100	1940

In the technical description the basic standard is given. Further customisation of the lift tables is possible due to an extensive range of options.

## Hymo Lift table DX

Hymo DX is used at lifting capacities from 3000 kg. Is available in many standard sizes and in special sizes on demand.



## Hymo Lift table DXT

### HORIZONTAL DOUBLE-SCISSORS

Hymo DXT is designed for big lifting capacities and long lifting platforms.

Hymo DX and DXT are designed to meet highest capacity requirements and reliability. The tables are today's clear solution for tasks in the upper heavy weight class – as materials lifts and complete loading platforms or as lifts for moving goods between differing floor levels.

## Hymo Lift table LX

Hymo LX has a lifting capacity up to 10 000 kg and a stroke of up to 1600 mm. Hymo LX is designed to meet the demands of high precision and reliability when bridging level differences within heavy industry. Hymo LX is specially adapted to loading bay applications and is equipped for external locations.

## Hymo Lift table LX



Single-scissors

TYPE	LX30-16/20	LX40-16/20	LX60-16/20	LX100-16/20
LIFTING CAPACITY, Kg	3000	4000	6000	10000
LIFT TRAVEL, mm	1600	1600	1600	1600
CLOSED HEIGHT, mm	305	450	450	650
PLATFORM LENGTH, mm	3000	3000	3000	3000
PLATFORM WIDTH, mm	2000	2000	2000	2000
LIFTING TIME, s	33	26	33	48
MOTOR POWER, kW	2.2	4.6	4.6	4.6
WEIGHT, kg	1330	1650	1750	3400

In the technical description the basic standard is given. Further customisation of the lift tables is possible due to an extensive range of options.



# Quality and high performance

Hymo delivers a high performance and quality product in every standard and customised solution. This is backed up by the fact that customers constantly come back again and again and recommend Hymo to their customers. In collaboration with the customer, Hymo designs the right solution to meet the current handling problem, then delivers equipment which fulfils that demand.



# Market – subsidiaries – distributors – concern

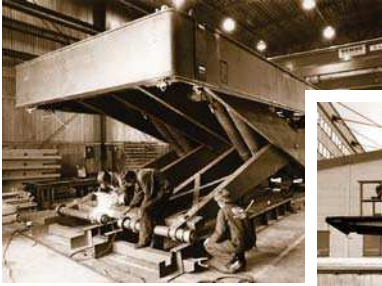

## 2006 –

The Hymo concern continues to take market shares on standard products and customisation. The catalogue sales are increasing and Hymo products are introduced in around 30 catalogues in Europe.

## 1956 – 1977

The first agreement with export distributors is established in 1961. The subsidiaries are mainly selling companies. Hymo Lift Ltd in England is established in 1967. After 1994 the company name is Hymo Limited. In the early seventies there is some production at Hymo in England. Hymo S.A. in France is established in 1976.

## 1978 – 1991

The subsidiary Hymo GmbH is established in 1988. Hymo S.A. in France moves from Paris to Lyon in 1991.



## Development – future

The companies within the Hymo concern are developing by wisdom and global experience. Hymo's experience and capacity as adviser regarding applications is often decisive for the efficiency of the customer's total material

## 1992 – 2000

At the subsidiaries the sales is mainly concentrated on standard and tailored standard products. Apart from the standard products with customisation, the mother company has a great amount of catalogue sales.

The main companies are Manutan in France, Logistep in Finland and Gigant (Luna) in Sweden. In 1997 the product range is divided in Optima and Maxima.

## 2000 – 2006

Hymo AB is now a subsidiary in the Marco Group AB. This concern membership has a positive effect at purchase, enlargement of the product range as well as profit.

handling and logistics operations. Hymo stands for **Support – Quality – Delivery certainty**. From the beginning more than 50 years ago, Hymo has developed to a standard creator within the product Lifting Tables. **100 000 units** are delivered around the world since 1956.



Hymo's product development aims on a wider range of application and increased safety to satisfy the high demands from the market.

**Hymo – always on the right level**



# Accessories MAXIMA

The Hymo Maxima range has a good selection of standard lift tables. In addition to this there is an extensive range of accessories, which enable the table to be tailored in every detail to suit customers' need.

Here are some examples on accessories.

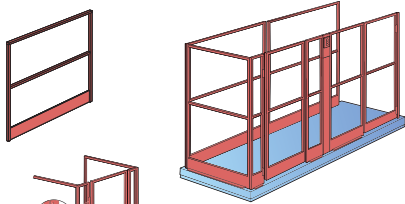

**Handrails and gates**  
Prevents people or goods from falling off the platform.

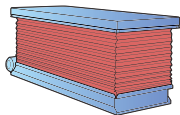

**Collapsible bellows guard**  
Encloses the scissor package and is effective in protecting against dust and dirt which reduces wear.

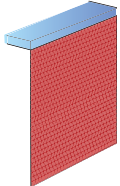

**Collapsible steel mesh guarding**  
Encloses the scissor package and prevents smaller objects getting under the table.

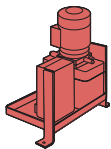

**Power unit**  
By choosing between different versions of the power pack, the lifting speed can be customised to your needs – a more powerful power pack raises the table faster. A freestanding power pack makes it possible to isolate a noisy environment, protects the unit from dirt and dust and makes the power pack easy to service.

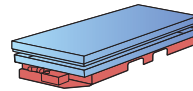

**Fork entry base frame**  
Facilitates easy transport of the table using a pallet truck.

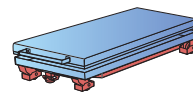

**Mobile base with handle**  
Makes it easier to move the table between different locations.

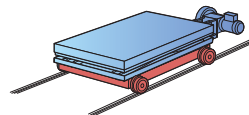

**Rail wheel chassis**  
For the horizontal fixed-path movement of the table on rails.

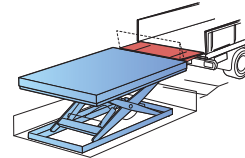

**Loading flap**  
Bridges the gap between the lift table and the vehicle.

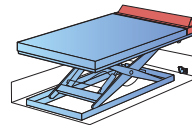

**Safety flap**  
Provides 'roll off' protection.

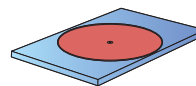

**Turntable**  
Increases accessibility. When loading or unloading pallets by hand, the load can be rotated to any position to give the most convenient working position or change the direction of goods within a conveyor system.



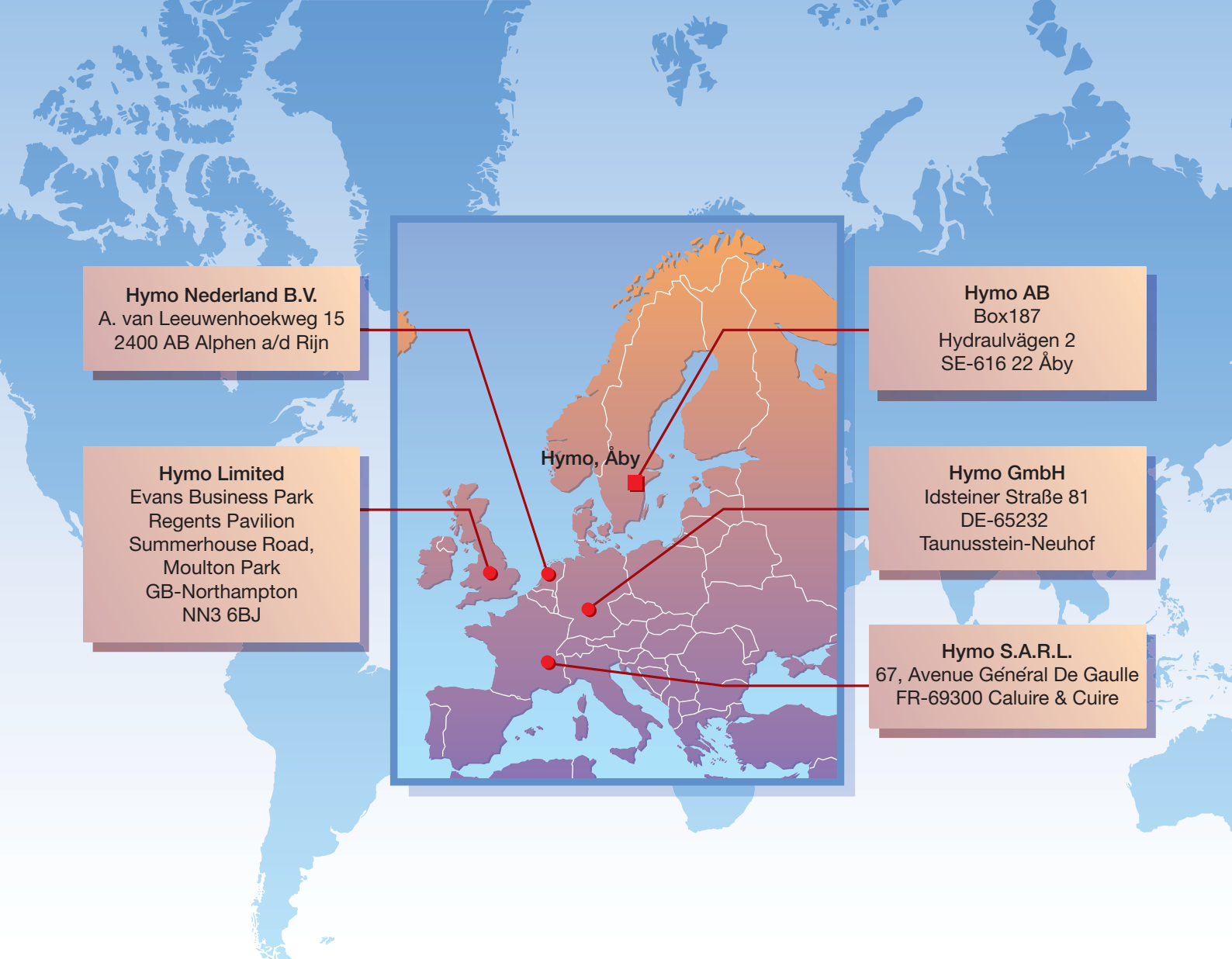

**Hymo Nederland B.V.**  
A. van Leeuwenhoekweg 15  
2400 AB Alphen a/d Rijn

**Hymo AB**  
Box187  
Hydraulvägen 2  
SE-616 22 Åby

**Hymo Limited**  
Evans Business Park  
Regents Pavilion  
Summerhouse Road,  
Moulton Park  
GB-Northampton  
NN3 6BJ

**Hymo GmbH**  
Idsteiner Straße 81  
DE-65232  
Tausenstein-Neuhof

**Hymo S.A.R.L.**  
67, Avenue Général De Gaulle  
FR-69300 Caluire & Cuire



[www.hymo.com](http://www.hymo.com)

## Hymo Lift table – taking the load

Hymo AB, Box 187, SE-616 22 Åby, Sweden. Tel +46 11 368700.  
Fax +46 11 368701. E-mail: [info@hymo.se](mailto:info@hymo.se)