



The stair climber for professionals

CargoMaster

A



Ideen bewegen mehr



To lift heavy loads up and down stairs is one of the most challenging problems of transportation. For the most part two physically strong persons are necessary for the task. Their backs and joints are extremely strained and the risk of accidents is high.

The CargoMaster transports virtually all heavy loads with ease and little physical effort up and down stairs. One person operating the device is generally sufficient.

The A-series of the CargoMaster is particularly suitable for the transportation of extremely heavy and/or bulky goods. In such situations safety and stability are our foremost priority.

The A350 is our special device for really heavy loads. It carries goods up to 350 kg thus lending itself particularly well for the transportation of furnaces, stoves and heating boilers. The A142 is ideal for the safe transport of primarily electrical devices and washing machines.

Minimize personnel and health risks, CargoMaster professionally takes over your heavy loads.

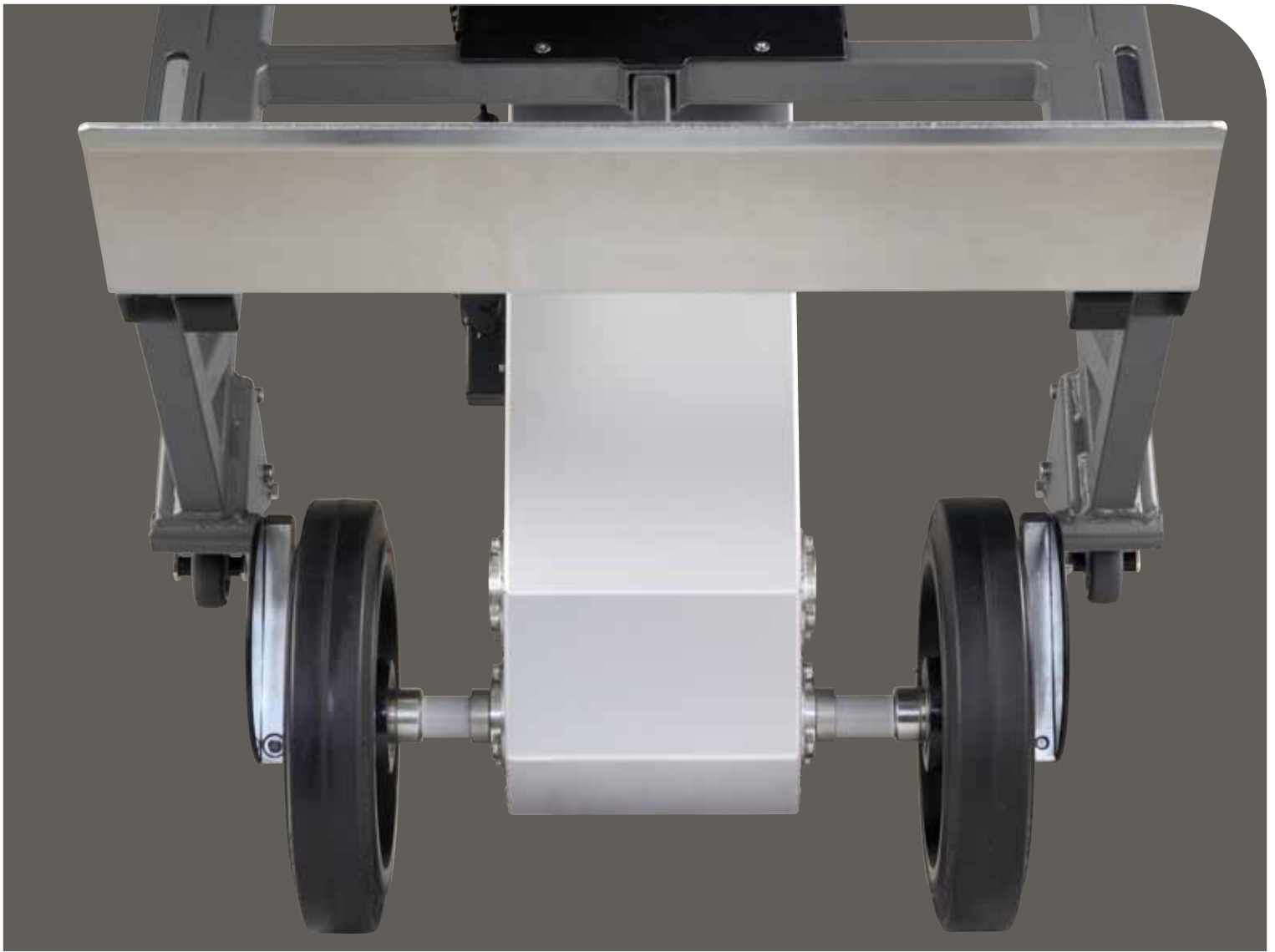

CargoMaster transports loads up to 350 kg upstairs and downstairs.

Transport heavy loads safely over stairs — CargoMaster spares your back and your wallet



CargoMaster assumes the load — you assume the responsibility

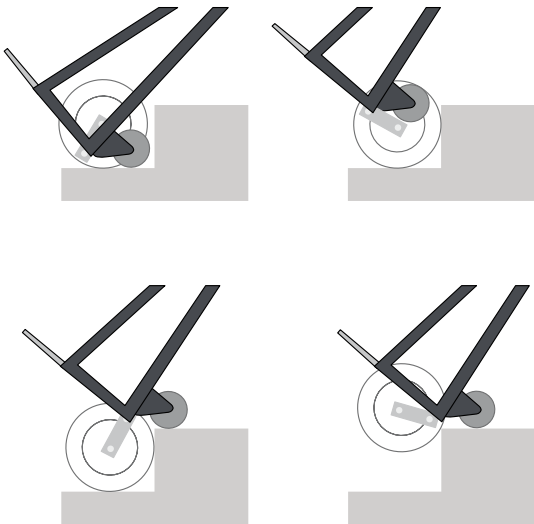

The reliable climbing mechanism conquers safely step after step.

It is always a critical and complicated affair to transport heavy loads. Be it a heating boiler or a washing machine, the CargoMaster safely transports heavy goods without damaging the stairs. Even narrow stairways are no problem for the CargoMaster. Its safe climbing mechanism conquers even winding stairs.

Because of its continuously adjustable speed, the CargoMaster adapts to all kinds of different circumstances. Safety brakes stop automatically at the edge of any step.



Its strong electric drive is powered by batteries, which can be easily removed. With a charging cable for the car the batteries can be charged en route. A second set of batteries makes a continuous use of the CargoMaster possible.

Due to their great ground clearance the models of the A-series are also suitable for construction sites. Even if the ground is rough and small stones or nails are strewn all over, the CargoMaster can be safely operated. Thanks to the solid-rubber tyres the CargoMaster does not break down, even when in constant use under rough conditions.

Before, at least two men carried heavy goods upstairs and downstairs, while now, with the CargoMaster, the same task is performed effortlessly by one person only. The stair climber for professionals spares your employees and your wallet because with the help of the CargoMaster one person operating the device is sufficient most of the time. So it is paid for in a very short time.



Due to its great ground clearance the device can be safely handled even on rough terrain.



At the grip you may adjust the climbing speed continuously.



The A350 is not impressed by big, bulky loads

If you have really heavy and bulky loads to transport up- and downstairs we would like to offer you our strongest model. The A350 transports loads up to 350 kg, thus the device lends itself particularly well for the transportation of heavy-weights such as heating boilers or service cabinets. A particularly strong frame makes sure that even at the limit of the loading capacity it is still safe to handle the CargoMaster.

Video

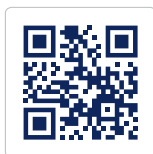

The adjustable toe plate makes it possible to shift the center of gravity and distribute the load so that it can be transported safely. Locking bolts keep the toe plate securely fixed.

CargoMaster

A350



The adjustable toe plate makes it possible to manipulate the centre of gravity.

When you transport particularly heavy loads we consider safety our highest priority. For difficult situations the standard A350 is equipped with a single step mode. The continuously adjustable speed further helps to control and master tricky situations.

Depending on the area of application the A350 can be equipped with easy running wheels or — for loads above 250 kg — with heavy-duty wheels. Both types of wheels do not damage easily.

Due to the handles, adjustable in height, the A350 can adapt to the operator's personal height as well as to particular tasks of transportation. On level ground you may use the Cargomaster as a trolley.





Transportation of washers, dryers, refrigerators, etc. up and down several floors — no problem with the A142

Your washer needs to go to the fifth floor? There is no lift? No problem with the versatile CargoMaster A142.

Particularly developed for the transportation of washers, dryers, and the like the A142 carries everything up to 140 kg safely up- and downstairs, even if the stairways should get narrow.

In addition to refrigerators or dryers heavy stacks of tiles or cement bags can be transported easily with the A142 without the danger of straining your employees' intervertebral disks or breaking the load.

Video



CargoMaster

A142



Due to the grips adjustable in height, the device can be ideally adapted to the operator's height. Therefore, goods are easily, safely and comfortably transported.

CargoMaster is your solution, not only for the transportation of heavy goods upstairs and downstairs, but also when loading or unloading said goods. Regardless of whether you are inside or outside, the CargoMaster is suitable to virtually all types of stairs.

The single step mode, integrated in the standard model, can be switched on thus making the device's handling particularly easy and comfortable.



In addition to the comfortable and easy transport upstairs and downstairs, the A 142 comes in handy when loading or unloading goods.

CargoMaster

A142



Basic equipment and accessories — for all situations of transportation

The delivery package includes a stair climber (A142 or A350) plus battery pack, charger and lashing straps.

Accessories for the A142



Battery pack

Extra batteries allowing for continuous operation.

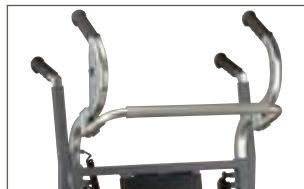

Support bow

To transport tall loads.



Charging cable for the car

Available for 12V and 24V.



Portable stairs

3- 14- 15-stairs



Support for round goods

With a diameter of approx. 150 to 800 mm.



Back wall

To avoid potential damage of the goods.



Platform

For the horizontal transportation of goods.



Special toe plates

Toe plates of 25cm and 40 cm are in stock; special sizes are available on demand.

CargoMaster

A350



The A350 is available in two different color schemes

Accessories for the A350



Battery pack

Extra batteries allowing for continuous operation.

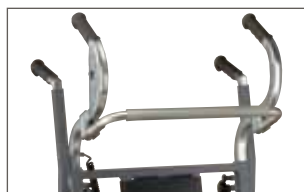

Support bow

To transport tall loads.



Charging cable for the car

Available for 12V and 24V.



Portable stairs

3- | 4- | 5-stairs

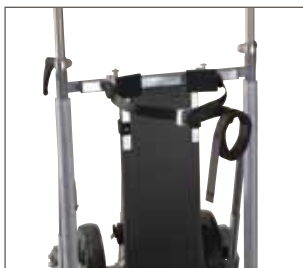

Support for round goods

With a diameter of approx. 150 to 800 mm.



Back wall

To avoid potential damage of the goods.



Special toe plates

The A350's toe plate is adjustable in height. Customized toe plates are available.



Vertical lift (manual)

To lift or lower goods up to 310 kg.

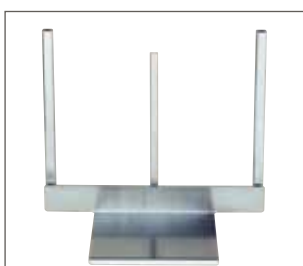

Special fork

To transport copy machines.



Wheel for transportation

Makes the transportation on level ground easy.

CargoMaster A-series — the stair climber for professionals

At AAT we design intelligent technology supporting and relieving you concerning problems of transportation.

Our knowledge and skill we derive from long experience which we invest into the development of innovative power systems and climbing aids such as the CargoMaster offering you numerous advantages:

- **particularly suitable for the transportation of heating furnaces, ovens, service cabinets and household appliances**
- **crucial relief for your delivery personnel**
- **safe transportation of heavy goods up to 350 kg upstairs and downstairs**
- **extra wide toe plate for a secure seat of the load**
- **ample ground clearance**
- **no damage of goods or stairs**
- **continuously adjustable climbing speed**
- **maintenance-free**
- **tyres that don't break down**



A350 online



A142 online

cargomaster_a_gb_01_2013 (1.1)

CE Der CargoMaster A-System coincides with the European Guidelines 2006/42/EG.

In the name of progress we reserve the right for technical changes.

The company AAT Alber Antriebstechnik is certified according to DIN EN ISO 9001:2008.

Technical data	A142	A350
Load capacity in kg	140	350
Climbing speed (steps/minute)	8-25	4-10
Capacity with one charge of the battery (floors, depending on the load)	30-50	15-30
Width in mm	580	590
Depth in mm	470	520
Height in mm	1110-1700	1195-1785
Total weight CargoMaster in kg	26	40
Total weight Battery pack in kg	6	6
Total weight including batteries in kg	32	46